

# RES SOPzV

## Technical Data



BATTERIES



SOLAR PV



WIND



GENSET



GRID



# SUNLIGHT

## Product Range

2V Cell Type	Capacity (Ah at 20°C)				Dimensions				Weight kg	Internal Resistance (mOhm)	Short Circuit Current (A)
	C120 Uf=1.85V	C48 Uf=1.80V	C24 Uf=1.80V	C12 Uf=1.75V	Length (mm)	Width (mm)	Height <sub>1</sub> (mm)	Height <sub>2</sub> (mm)			
RES 2 SOPzV 150	150	145	135	126	198	47	343	370	9.0	1.58	1280
RES 3 SOPzV 225	225	218	203	189	198	65	343	370	12.7	1.08	1900
RES 2 SOPzV 280	284	279	260	244	198	47	568	595	15.4	1.08	1900
RES 3 SOPzV 425	426	419	390	366	198	65	568	595	22.0	0.72	2840
RES 4 SOPzV 565	568	558	520	488	198	83	568	595	28.7	0.54	3780
RES 5 SOPzV 710	710	698	650	611	198	101	568	595	35.3	0.43	4740
RES 6 SOPzV 850	852	838	780	733	198	119	568	595	42.1	0.36	5680
RES 7 SOPzV 990	994	977	911	855	198	137	568	595	48.8	0.31	6620
RES 8 SOPzV 1135	1136	1116	1041	977	198	155	568	595	55.5	0.27	7580
RES 7 SOPzV 1190	1190	1171	1087	1024	198	137	713	740	60.0	0.31	6560
RES 8 SOPzV 1360	1360	1338	1242	1170	198	155	713	740	68.1	0.27	7500

Technical details may be subject to alterations.

## Drawings

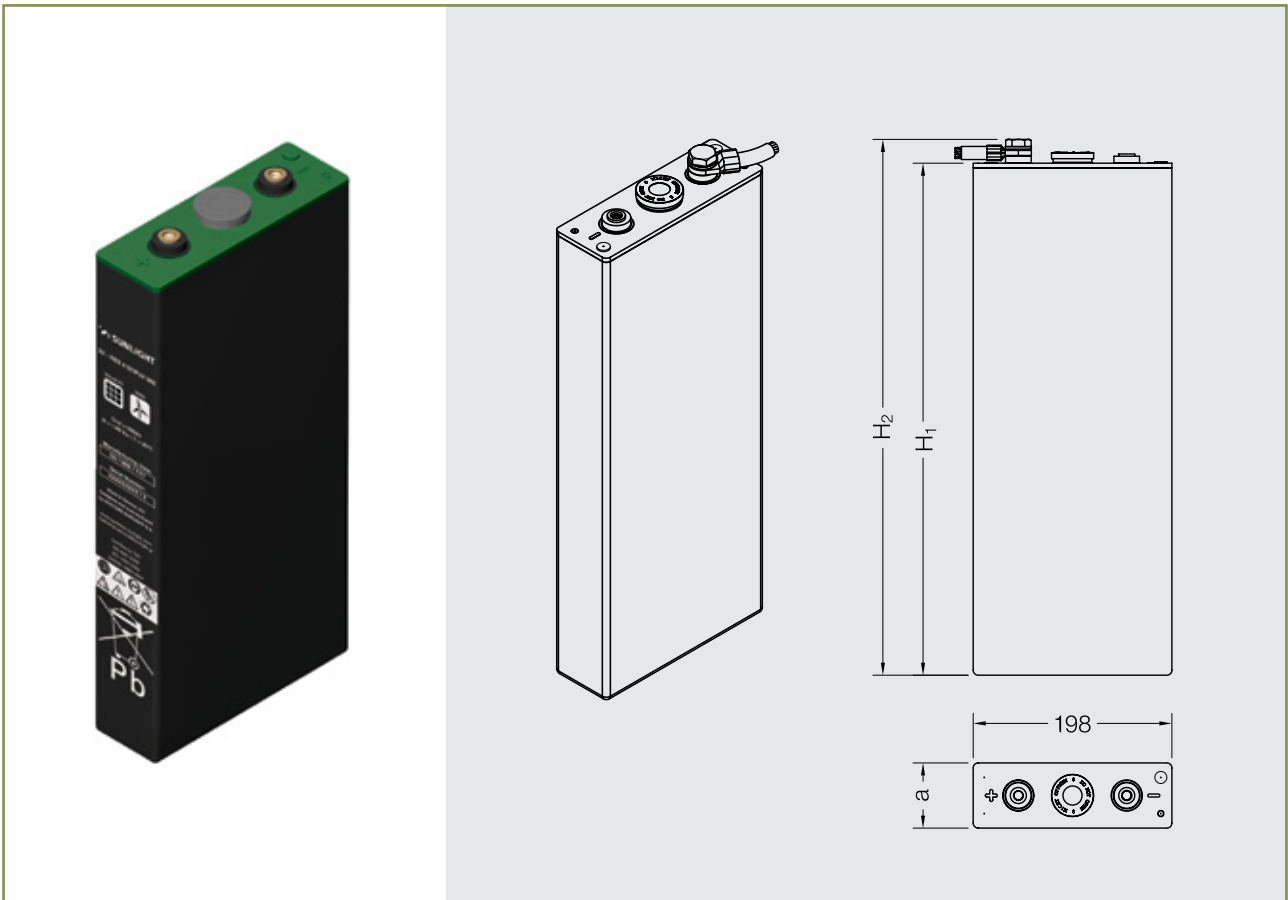

## Technical Features

### Design

<b>Positive plates</b>	Tubular plates with corrosion resistant Lead Calcium Tin Alloy.
<b>Negative plates</b>	Pasted negative plates of grid design with optimized Lead Calcium Tin Alloy.
<b>Separators</b>	Low resistance, microporous PVC.
<b>Electrolyte</b>	Diluted sulphuric acid fixed as GEL.
<b>Container, lid material</b>	Polypropylene (PP) with lid welding, trimming and tightness control.
<b>Poles</b>	Premium design with insert and rubber seal in the lid for hardness and acid resistance. M10 brass inlay. Impedance measurements possible.
<b>Connectors</b>	Accurate voltage measurements possible due to bolt-on type design. Steel bolts with plastic encapsulated heads. Insulated flexible connectors.
<b>Pressure relief valve</b>	Relief valve with integral flame arrestor.

### Operation

<b>Number of cycles</b>	2000 cycles for 60% DoD at 20°C.
<b>Design life</b>	15 years (stand-by float, 20°C).
<b>Maintenance</b>	No water refilling during life.
<b>Operating temperature</b>	Recommended 15°C to 35°C. Min: -20°C / Max: 45°C.
<b>Storage Time</b>	Maximum shelf life up to 6 months at 20°C, 4 months at 30°C or 2 months at 40°C.
<b>Self discharge rate</b>	Approx. 2 % per month at 20°C.

### Certified Quality

- Manufactured at SUNLIGHT's European production facilities, certified with ISO 9001, ISO 14001, BS OHSAS 18001
- Compliant with IEC 61427 requirements for photovoltaic energy systems
- "Long Life" according to Eurobat classification
- Tested according to IEC 60896-21 and fully compliant with IEC 60896-22 requirements for valve regulated batteries
- Compliant with the safety requirements of EN 50272-2 for stationary batteries

## Performance Curves

### Expected Number of Cycles vs. DoD

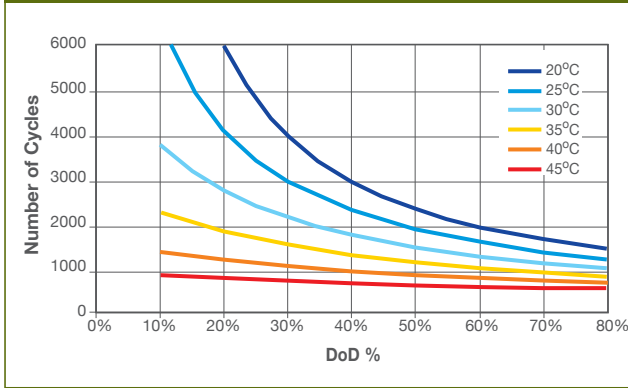

### Self-discharge Characteristics

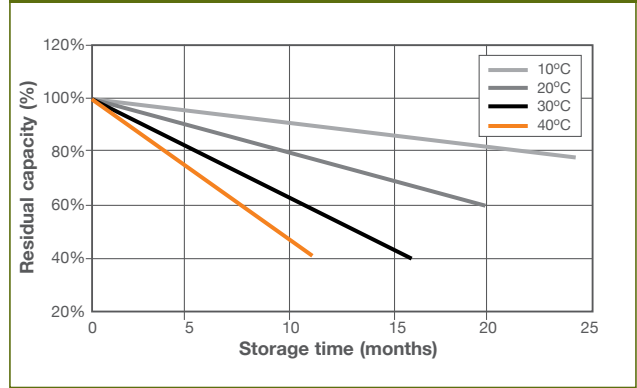

### Capacity vs. Temperature

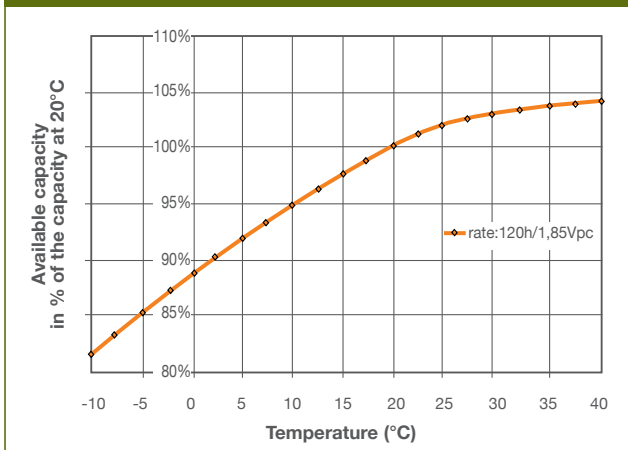

### Low-voltage Disconnect Settings

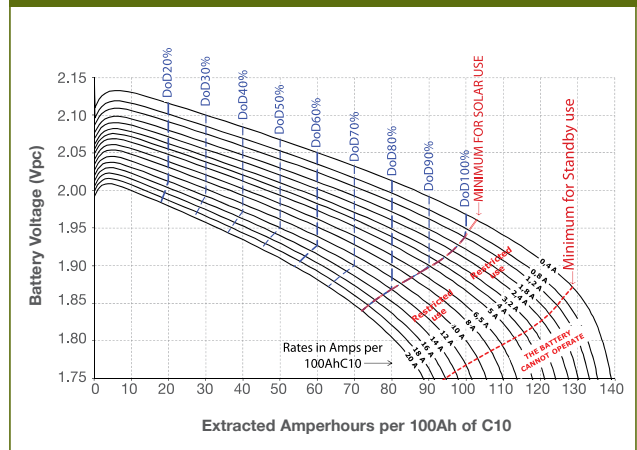

### Charging Settings for Stand-alone Systems

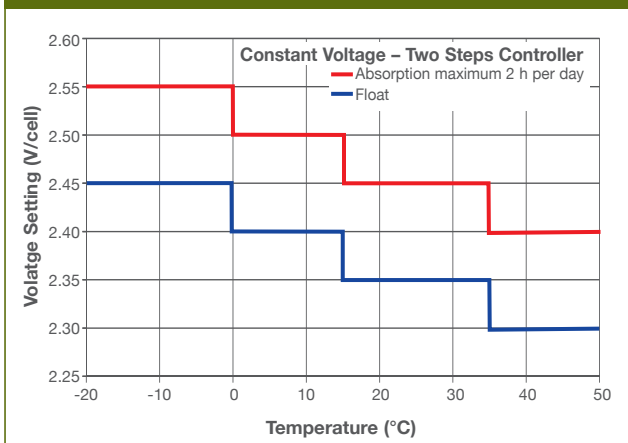

### Charging Settings for Hybrid Systems

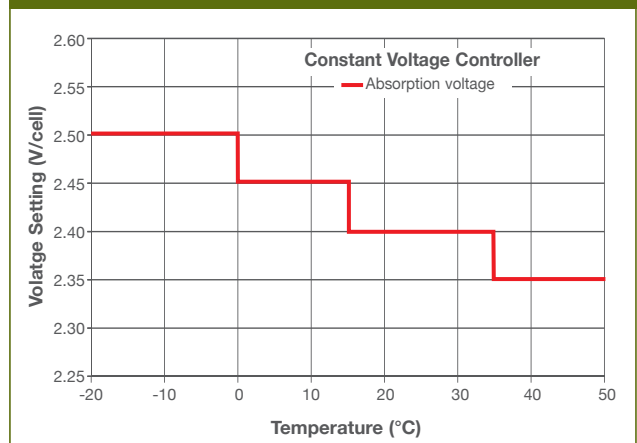

## Performance Data

### Discharge Constant Current at 20°C (Amperes)

End Voltage 1.60 V/cell												
	1 h	2 h	3 h	4 h	5 h	6 h	7 h	8 h	10 h	12 h	16 h	20 h
RES 2 SOPzV 150	74.56	45.47	33.45	26.74	22.38	19.31	17.02	15.24	12.64	10.83	8.46	6.97
RES 3 SOPzV 225	111.83	68.20	50.18	40.12	33.58	28.97	25.53	22.86	18.96	16.25	12.69	10.45
RES 2 SOPzV 280	142.93	87.55	64.61	51.70	43.33	37.42	33.01	29.57	24.55	21.03	16.42	13.50
RES 3 SOPzV 425	214.39	131.33	96.91	77.55	64.99	56.13	49.51	44.36	36.82	31.55	24.62	20.25
RES 4 SOPzV 565	285.86	175.10	129.21	103.40	86.65	74.84	66.01	59.14	49.10	42.07	32.83	26.99
RES 5 SOPzV 710	357.32	218.88	161.52	129.25	108.31	93.55	82.52	73.93	61.37	52.59	41.04	33.74
RES 6 SOPzV 850	428.78	262.65	193.82	155.10	129.98	112.26	99.02	88.71	73.64	63.10	49.25	40.49
RES 7 SOPzV 990	500.25	306.43	226.12	180.94	151.64	130.97	115.52	103.50	85.92	73.62	57.45	47.24
RES 8 SOPzV 1135	571.71	350.21	258.43	206.79	173.30	149.68	132.03	118.29	98.19	84.14	65.66	53.99
RES 7 SOPzV 1190	593.16	366.98	271.34	217.33	182.24	157.45	138.93	124.49	103.38	88.61	69.17	56.89
RES 8 SOPzV 1360	677.90	419.41	310.11	248.38	208.27	179.95	158.77	142.28	118.15	101.26	79.06	65.02

End Voltage 1.65 V/cell												
	1 h	2 h	3 h	4 h	5 h	6 h	7 h	8 h	10 h	12 h	16 h	20 h
RES 2 SOPzV 150	73.68	45.06	33.17	26.53	22.21	19.16	16.89	15.12	12.55	10.75	8.40	6.92
RES 3 SOPzV 225	110.52	67.59	49.76	39.80	33.31	28.74	25.33	22.69	18.82	16.13	12.60	10.37
RES 2 SOPzV 280	139.92	86.60	64.03	51.27	42.99	37.14	32.76	29.36	24.37	20.89	16.30	13.41
RES 3 SOPzV 425	209.88	129.90	96.04	76.91	64.48	55.71	49.15	44.04	36.56	31.33	24.46	20.11
RES 4 SOPzV 565	279.84	173.21	128.06	102.55	85.98	74.28	65.53	58.72	48.75	41.78	32.61	26.81
RES 5 SOPzV 710	349.80	216.51	160.07	128.19	107.47	92.85	81.91	73.39	60.94	52.22	40.76	33.52
RES 6 SOPzV 850	419.75	259.81	192.08	153.82	128.97	111.42	98.29	88.07	73.12	62.67	48.91	40.22
RES 7 SOPzV 990	489.71	303.11	224.10	179.46	150.46	129.99	114.68	102.75	85.31	73.11	57.06	46.92
RES 8 SOPzV 1135	559.67	346.41	256.11	205.10	171.96	148.56	131.06	117.43	97.50	83.55	65.21	53.63
RES 7 SOPzV 1190	572.21	361.79	268.42	215.27	180.62	156.12	137.79	123.50	102.58	87.93	68.66	56.48
RES 8 SOPzV 1360	653.96	413.47	306.77	246.02	206.43	178.43	157.47	141.14	117.23	100.50	78.47	64.55

End Voltage 1.70 V/cell												
	1 h	2 h	3 h	4 h	5 h	6 h	7 h	8 h	10 h	12 h	16 h	20 h
RES 2 SOPzV 150	72.25	44.47	32.79	26.24	21.97	18.96	16.72	14.97	12.42	10.64	8.32	6.85
RES 3 SOPzV 225	108.38	66.70	49.18	39.36	32.96	28.44	25.07	22.45	18.63	15.97	12.47	10.27
RES 2 SOPzV 280	133.89	84.93	63.10	50.62	42.48	36.72	32.41	29.05	24.13	20.68	16.15	13.28
RES 3 SOPzV 425	200.84	127.40	94.64	75.93	63.72	55.09	48.62	43.57	36.19	31.02	24.22	19.92
RES 4 SOPzV 565	267.79	169.86	126.19	101.24	84.97	73.45	64.82	58.10	48.26	41.36	32.29	26.56
RES 5 SOPzV 710	334.73	212.33	157.74	126.55	106.21	91.81	81.03	72.62	60.32	51.70	40.37	33.20
RES 6 SOPzV 850	401.68	254.79	189.29	151.86	127.45	110.17	97.23	87.15	72.39	62.05	48.44	39.84
RES 7 SOPzV 990	468.63	297.26	220.84	177.17	148.69	128.53	113.44	101.67	84.45	72.39	56.52	46.48
RES 8 SOPzV 1135	535.57	339.72	252.39	202.48	169.93	146.90	129.65	116.20	96.51	82.73	64.59	53.12
RES 7 SOPzV 1190	538.12	351.70	263.36	211.89	178.09	154.08	136.07	122.01	101.41	86.96	67.93	55.90
RES 8 SOPzV 1360	614.99	401.95	300.98	242.16	203.53	176.10	155.51	139.44	115.89	99.38	77.64	63.88

## Performance Data

### Discharge Constant Current at 20°C (Amperes)

End Voltage 1.75 V/cell												
	1 h	2 h	3 h	4 h	5 h	6 h	7 h	8 h	10 h	12 h	16 h	20 h
RES 2 SOPzV 150	69.47	43.48	32.18	25.79	21.62	18.67	16.46	14.74	12.24	10.49	8.20	6.75
RES 3 SOPzV 225	104.20	65.22	48.28	38.69	32.43	28.00	24.69	22.12	18.36	15.74	12.30	10.13
RES 2 SOPzV 280	124.68	81.45	61.26	49.41	41.58	36.00	31.81	28.54	23.73	20.35	15.90	13.09
RES 3 SOPzV 425	187.02	122.17	91.89	74.11	62.37	54.01	47.72	42.80	35.59	30.53	23.85	19.63
RES 4 SOPzV 565	249.36	162.89	122.52	98.82	83.16	72.01	63.62	57.07	47.45	40.70	31.80	26.17
RES 5 SOPzV 710	311.70	203.62	153.15	123.52	103.95	90.01	79.53	71.34	59.31	50.88	39.76	32.72
RES 6 SOPzV 850	374.04	244.34	183.78	148.22	124.74	108.01	95.44	85.61	71.18	61.05	47.71	39.26
RES 7 SOPzV 990	436.38	285.07	214.41	172.93	145.54	126.02	111.34	99.87	83.04	71.23	55.66	45.80
RES 8 SOPzV 1135	498.72	325.79	245.04	197.63	166.33	144.02	127.25	114.14	94.90	81.40	63.61	52.35
RES 7 SOPzV 1190	494.22	332.07	252.80	205.14	173.22	150.28	132.96	119.38	99.38	85.31	66.74	54.96
RES 8 SOPzV 1360	564.82	379.50	288.91	234.44	197.96	171.75	151.96	136.43	113.58	97.50	76.27	62.81

End Voltage 1.80 V/cell												
	6 h	7 h	8 h	10 h	12 h	24 h	48 h	72 h	100 h	120 h	168 h	240 h
RES 2 SOPzV 150	18.16	16.03	14.37	11.94	10.24	5.63	3.02	2.08	1.54	1.29	0.94	0.67
RES 3 SOPzV 225	27.24	24.04	21.55	17.91	15.36	8.44	4.54	3.13	2.30	1.94	1.41	1.00
RES 2 SOPzV 280	34.48	30.55	27.47	22.91	19.69	10.84	5.82	3.99	2.93	2.46	1.78	1.27
RES 3 SOPzV 425	51.72	45.83	41.20	34.37	29.54	16.26	8.72	5.99	4.39	3.69	2.67	1.90
RES 4 SOPzV 565	68.96	61.11	54.94	45.82	39.39	21.68	11.63	7.99	5.86	4.92	3.57	2.53
RES 5 SOPzV 710	86.20	76.39	68.67	57.28	49.23	27.10	14.54	9.98	7.32	6.15	4.46	3.16
RES 6 SOPzV 850	103.44	91.66	82.41	68.73	59.08	32.52	17.45	11.98	8.79	7.38	5.35	3.80
RES 7 SOPzV 990	120.68	106.94	96.14	80.19	68.93	37.94	20.35	13.98	10.25	8.62	6.24	4.43
RES 8 SOPzV 1135	137.92	122.22	109.88	91.64	78.77	43.36	23.26	15.97	11.71	9.85	7.13	5.06
RES 7 SOPzV 1190	142.21	126.30	113.74	95.09	81.87	45.28	24.39	16.78	12.32	10.36	7.51	5.34
RES 8 SOPzV 1360	162.53	144.35	129.98	108.67	93.57	51.75	27.87	19.18	14.08	11.84	8.59	6.10

End Voltage 1.85 V/cell												
	6 h	7 h	8 h	10 h	12 h	24 h	48 h	72 h	100 h	120 h	168 h	240 h
RES 2 SOPzV 150	17.12	15.15	13.61	11.34	9.75	5.39	2.91	2.01	1.48	1.25	0.91	0.65
RES 3 SOPzV 225	25.68	22.73	20.42	17.02	14.63	8.08	4.36	3.01	2.22	1.87	1.37	0.97
RES 2 SOPzV 280	31.70	28.18	25.39	21.26	18.33	10.20	5.53	3.82	2.81	2.37	1.72	1.22
RES 3 SOPzV 425	47.55	42.26	38.09	31.89	27.50	15.30	8.29	5.73	4.21	3.55	2.58	1.84
RES 4 SOPzV 565	63.40	56.35	50.79	42.53	36.67	20.40	11.06	7.63	5.62	4.73	3.44	2.45
RES 5 SOPzV 710	79.25	70.44	63.48	53.16	45.83	25.50	13.82	9.54	7.02	5.92	4.30	3.06
RES 6 SOPzV 850	95.09	84.53	76.18	63.79	55.00	30.60	16.59	11.45	8.43	7.10	5.16	3.67
RES 7 SOPzV 990	110.94	98.61	88.87	74.42	64.16	35.70	19.35	13.36	9.83	8.28	6.02	4.29
RES 8 SOPzV 1135	126.79	112.70	101.57	85.05	73.33	40.80	22.12	15.27	11.24	9.47	6.88	4.90
RES 7 SOPzV 1190	129.19	115.08	103.88	87.19	75.30	42.14	22.99	15.93	11.76	9.92	7.22	5.15
RES 8 SOPzV 1360	147.65	131.51	118.72	99.65	86.06	48.16	26.27	18.21	13.44	11.33	8.25	5.88

## Performance Data

### Discharge Constant Current at 20°C (Amperes)

End Voltage 1.90 V/cell												
	6 h	7 h	8 h	10 h	12 h	24 h	48 h	72 h	100 h	120 h	168 h	240 h
RES 2 SOPzV 150	15.28	13.57	12.22	10.23	8.82	4.92	2.68	1.86	1.38	1.16	0.85	0.61
RES 3 SOPzV 225	22.92	20.36	18.34	15.34	13.23	7.38	4.02	2.79	2.07	1.75	1.28	0.91
RES 2 SOPzV 280	27.85	24.83	22.43	18.85	16.29	9.15	5.01	3.48	2.58	2.18	1.59	1.14
RES 3 SOPzV 425	41.78	37.24	33.64	28.27	24.44	13.73	7.52	5.22	3.87	3.27	2.39	1.71
RES 4 SOPzV 565	55.71	49.65	44.86	37.69	32.58	18.31	10.03	6.96	5.15	4.35	3.18	2.28
RES 5 SOPzV 710	69.63	62.07	56.07	47.11	40.73	22.89	12.53	8.70	6.44	5.44	3.98	2.85
RES 6 SOPzV 850	83.56	74.48	67.28	56.54	48.87	27.46	15.04	10.45	7.73	6.53	4.77	3.42
RES 7 SOPzV 990	97.49	86.90	78.50	65.96	57.02	32.04	17.55	12.19	9.02	7.62	5.57	3.99
RES 8 SOPzV 1135	111.41	99.31	89.71	75.38	65.17	36.62	20.05	13.93	10.31	8.71	6.37	4.56
RES 7 SOPzV 1190	111.82	99.93	90.45	76.23	66.04	37.41	20.67	14.42	10.71	9.06	6.64	4.76
RES 8 SOPzV 1360	127.79	114.21	103.37	87.12	75.48	42.76	23.62	16.48	12.24	10.36	7.59	5.44

End Voltage 1.94 V/cell												
	6 h	7 h	8 h	10 h	12 h	24 h	48 h	72 h	100 h	120 h	168 h	240 h
RES 2 SOPzV 150	13.30	11.85	10.69	8.98	7.77	4.38	2.40	1.68	1.25	1.06	0.77	0.56
RES 3 SOPzV 225	19.95	17.77	16.04	13.47	11.65	6.56	3.61	2.51	1.87	1.58	1.16	0.83
RES 2 SOPzV 280	23.96	21.42	19.40	16.36	14.19	8.07	4.47	3.12	2.32	1.96	1.44	1.04
RES 3 SOPzV 425	35.94	32.13	29.10	24.55	21.29	12.11	6.70	4.68	3.48	2.95	2.16	1.56
RES 4 SOPzV 565	47.92	42.84	38.80	32.73	28.38	16.14	8.93	6.24	4.64	3.93	2.89	2.08
RES 5 SOPzV 710	59.90	53.55	48.50	40.91	35.48	20.18	11.17	7.80	5.80	4.91	3.61	2.60
RES 6 SOPzV 850	71.88	64.26	58.20	49.09	42.57	24.21	13.40	9.36	6.96	5.89	4.33	3.11
RES 7 SOPzV 990	83.85	74.97	67.90	57.28	49.67	28.25	15.64	10.92	8.12	6.88	5.05	3.63
RES 8 SOPzV 1135	95.83	85.68	77.60	65.46	56.76	32.28	17.87	12.48	9.28	7.86	5.77	4.15
RES 7 SOPzV 1190	94.54	84.78	76.95	65.16	56.67	32.61	18.27	12.84	9.59	8.14	5.99	4.32
RES 8 SOPzV 1360	108.05	96.89	87.95	74.47	64.77	37.27	20.88	14.67	10.96	9.30	6.85	4.94

End Voltage 2.00 V/cell												
	6 h	7 h	8 h	10 h	12 h	24 h	48 h	72 h	100 h	120 h	168 h	240 h
RES 2 SOPzV 150	9.54	8.55	7.75	6.57	5.72	3.30	1.85	1.31	0.98	0.83	0.62	0.45
RES 3 SOPzV 225	14.31	12.82	11.63	9.85	8.57	4.95	2.78	1.96	1.47	1.25	0.92	0.67
RES 2 SOPzV 280	16.85	15.16	13.80	11.75	10.28	6.03	3.43	2.43	1.82	1.55	1.15	0.84
RES 3 SOPzV 425	25.27	22.74	20.70	17.63	15.41	9.05	5.14	3.64	2.73	2.33	1.73	1.26
RES 4 SOPzV 565	33.69	30.32	27.60	23.51	20.55	12.06	6.85	4.85	3.65	3.11	2.31	1.68
RES 5 SOPzV 710	42.12	37.90	34.50	29.39	25.69	15.08	8.56	6.07	4.56	3.88	2.88	2.10
RES 6 SOPzV 850	50.54	45.48	41.41	35.26	30.83	18.09	10.28	7.28	5.47	4.66	3.46	2.52
RES 7 SOPzV 990	58.96	53.05	48.31	41.14	35.96	21.11	11.99	8.49	6.38	5.44	4.03	2.94
RES 8 SOPzV 1135	67.39	60.63	55.21	47.02	41.10	24.12	13.70	9.71	7.29	6.21	4.61	3.36
RES 7 SOPzV 1190	63.94	57.77	52.79	45.24	39.75	23.83	13.80	9.86	7.45	6.37	4.64	3.21
RES 8 SOPzV 1360	73.07	66.02	60.33	51.70	45.43	27.23	15.77	11.27	8.52	7.28	5.30	3.67

## Performance Data

### Discharge Constant Power at 20°C (Watts/cell)

End Voltage 1.60 V/cell												
	1 h	2 h	3 h	4 h	5 h	6 h	7 h	8 h	10 h	12 h	16 h	20 h
RES 2 SOPzV 150	132.06	83.20	62.11	50.10	42.19	36.57	32.35	29.05	24.22	20.83	16.36	13.52
RES 3 SOPzV 225	198.09	124.80	93.17	75.15	63.29	54.86	48.52	43.58	36.33	31.24	24.53	20.28
RES 2 SOPzV 280	247.43	157.72	118.44	95.78	80.85	70.21	62.19	55.91	46.67	40.16	31.53	26.04
RES 3 SOPzV 425	371.14	236.58	177.66	143.66	121.27	105.31	93.29	83.87	70.00	60.23	47.30	39.07
RES 4 SOPzV 565	494.86	315.44	236.88	191.55	161.70	140.41	124.38	111.83	93.34	80.31	63.06	52.09
RES 5 SOPzV 710	618.57	394.31	296.10	239.44	202.12	175.51	155.48	139.78	116.67	100.39	78.83	65.11
RES 6 SOPzV 850	742.28	473.17	355.32	287.33	242.54	210.62	186.57	167.74	140.00	120.47	94.60	78.13
RES 7 SOPzV 990	866.00	552.03	414.54	335.22	282.97	245.72	217.67	195.69	163.34	140.54	110.36	91.16
RES 8 SOPzV 1135	989.71	630.89	473.76	383.11	323.39	280.82	248.76	223.65	186.67	160.62	126.13	104.18
RES 7 SOPzV 1190	1006.59	652.23	491.99	398.74	337.05	292.96	259.69	233.60	195.12	167.99	132.00	109.09
RES 8 SOPzV 1360	1150.39	745.40	562.27	455.71	385.20	334.81	296.79	266.97	223.00	191.98	150.86	124.67

End Voltage 1.65 V/cell												
	1 h	2 h	3 h	4 h	5 h	6 h	7 h	8 h	10 h	12 h	16 h	20 h
RES 2 SOPzV 150	130.76	82.58	61.69	49.77	41.92	36.34	32.15	28.87	24.07	20.70	16.26	13.44
RES 3 SOPzV 225	196.15	123.87	92.54	74.66	62.89	54.51	48.22	43.31	36.10	31.05	24.38	20.16
RES 2 SOPzV 280	242.79	156.25	117.55	95.12	80.32	69.77	61.81	55.58	46.40	39.93	31.36	25.90
RES 3 SOPzV 425	364.18	234.38	176.32	142.68	120.49	104.65	92.72	83.37	69.60	59.89	47.03	38.85
RES 4 SOPzV 565	485.57	312.51	235.09	190.24	160.65	139.54	123.62	111.16	92.79	79.85	62.71	51.80
RES 5 SOPzV 710	606.96	390.63	293.86	237.80	200.81	174.42	154.53	138.95	115.99	99.82	78.39	64.75
RES 6 SOPzV 850	728.36	468.76	352.64	285.36	240.97	209.31	185.44	166.74	139.19	119.78	94.07	77.70
RES 7 SOPzV 990	849.75	546.89	411.41	332.91	281.14	244.19	216.34	194.52	162.39	139.74	109.75	90.66
RES 8 SOPzV 1135	971.14	625.01	470.18	380.47	321.30	279.07	247.25	222.31	185.59	159.71	125.42	103.61
RES 7 SOPzV 1190	976.07	644.11	487.44	395.53	334.54	290.89	257.92	232.04	193.87	166.93	131.20	108.44
RES 8 SOPzV 1360	1115.51	736.12	557.07	452.03	382.33	332.44	294.76	265.19	221.57	190.78	149.94	123.93

End Voltage 1.70 V/cell												
	1 h	2 h	3 h	4 h	5 h	6 h	7 h	8 h	10 h	12 h	16 h	20 h
RES 2 SOPzV 150	128.57	81.65	61.08	49.31	41.54	36.02	31.87	28.62	23.86	20.53	16.12	13.33
RES 3 SOPzV 225	192.85	122.48	91.62	73.96	62.32	54.03	47.80	42.94	35.80	30.79	24.18	19.99
RES 2 SOPzV 280	233.83	153.55	116.04	94.06	79.51	69.10	61.24	55.08	46.00	39.59	31.10	25.70
RES 3 SOPzV 425	350.75	230.33	174.06	141.10	119.26	103.65	91.86	82.62	69.00	59.39	46.65	38.55
RES 4 SOPzV 565	467.66	307.11	232.09	188.13	159.02	138.20	122.48	110.16	92.00	79.18	62.20	51.39
RES 5 SOPzV 710	584.58	383.89	290.11	235.16	198.77	172.75	153.11	137.70	115.00	98.98	77.76	64.24
RES 6 SOPzV 850	701.49	460.66	348.13	282.19	238.53	207.29	183.73	165.24	138.00	118.78	93.31	77.09
RES 7 SOPzV 990	818.41	537.44	406.15	329.22	278.28	241.84	214.35	192.78	160.99	138.57	108.86	89.94
RES 8 SOPzV 1135	935.33	614.22	464.17	376.26	318.03	276.39	244.97	220.32	183.99	158.37	124.41	102.79
RES 7 SOPzV 1190	928.98	627.93	479.21	390.06	330.43	287.58	255.13	229.63	191.96	165.35	130.01	107.49
RES 8 SOPzV 1360	1061.69	717.64	547.67	445.78	377.64	328.66	291.58	262.44	219.39	188.97	148.59	122.84



## Performance Data

### Discharge Constant Power at 20°C (Watts/cell)

End Voltage 1.75 V/cell												
	1 h	2 h	3 h	4 h	5 h	6 h	7 h	8 h	10 h	12 h	16 h	20 h
RES 2 SOPzV 150	124.22	80.05	60.09	48.58	40.96	35.53	31.44	28.25	23.56	20.27	15.93	13.17
RES 3 SOPzV 225	186.32	120.08	90.14	72.86	61.44	53.29	47.17	42.38	35.34	30.41	23.89	19.75
RES 2 SOPzV 280	220.47	147.92	112.99	92.04	78.00	67.89	60.24	54.22	45.32	39.04	30.69	25.37
RES 3 SOPzV 425	330.71	221.88	169.48	138.05	117.00	101.84	90.36	81.33	67.98	58.56	46.04	38.06
RES 4 SOPzV 565	440.94	295.84	225.97	184.07	156.00	135.79	120.48	108.44	90.65	78.07	61.38	50.74
RES 5 SOPzV 710	551.18	369.80	282.47	230.09	195.00	169.73	150.59	135.55	113.31	97.59	76.73	63.43
RES 6 SOPzV 850	661.41	443.76	338.96	276.11	234.00	203.68	180.71	162.65	135.97	117.11	92.07	76.11
RES 7 SOPzV 990	771.65	517.73	395.45	322.12	272.99	237.63	210.83	189.76	158.63	136.63	107.42	88.80
RES 8 SOPzV 1135	881.89	591.69	451.95	368.14	311.99	271.57	240.95	216.87	181.29	156.15	122.76	101.49
RES 7 SOPzV 1190	867.13	597.40	461.89	378.77	322.25	281.19	249.90	225.20	188.56	162.58	127.99	105.90
RES 8 SOPzV 1360	991.01	682.74	527.87	432.88	368.28	321.36	285.60	257.37	215.49	185.80	146.28	121.03

End Voltage 1.80 V/cell												
	6 h	7 h	8 h	10 h	12 h	24 h	48 h	72 h	100 h	120 h	168 h	240 h
RES 2 SOPzV 150	34.66	30.70	27.61	23.05	19.84	11.04	6.00	4.16	3.08	2.60	1.90	1.36
RES 3 SOPzV 225	51.99	46.06	41.41	34.57	29.76	16.55	9.00	6.24	4.62	3.91	2.86	2.04
RES 2 SOPzV 280	65.28	58.08	52.38	43.92	37.90	21.15	11.50	7.95	5.87	4.95	3.60	2.57
RES 3 SOPzV 425	97.92	87.11	78.57	65.87	56.85	31.73	17.24	11.93	8.80	7.42	5.41	3.86
RES 4 SOPzV 565	130.56	116.15	104.76	87.83	75.80	42.31	22.99	15.91	11.73	9.89	7.21	5.15
RES 5 SOPzV 710	163.20	145.19	130.95	109.79	94.75	52.88	28.74	19.88	14.67	12.37	9.01	6.43
RES 6 SOPzV 850	195.84	174.23	157.14	131.75	113.70	63.46	34.49	23.86	17.60	14.84	10.81	7.72
RES 7 SOPzV 990	228.48	203.26	183.33	153.70	132.65	74.03	40.24	27.84	20.53	17.32	12.62	9.01
RES 8 SOPzV 1135	261.11	232.30	209.52	175.66	151.59	84.61	45.98	31.81	23.47	19.79	14.42	10.29
RES 7 SOPzV 1190	267.51	238.52	215.51	181.15	156.62	87.89	47.99	33.29	24.60	20.76	15.14	10.82
RES 8 SOPzV 1360	305.72	272.60	246.30	207.03	178.99	100.44	54.85	38.05	28.12	23.73	17.31	12.37

End Voltage 1.85 V/cell												
	6 h	7 h	8 h	10 h	12 h	24 h	48 h	72 h	100 h	120 h	168 h	240 h
RES 2 SOPzV 150	32.85	29.17	26.28	22.00	18.97	10.61	5.79	4.03	2.99	2.53	1.85	1.32
RES 3 SOPzV 225	49.27	43.75	39.42	33.00	28.46	15.92	8.69	6.04	4.48	3.79	2.77	1.98
RES 2 SOPzV 280	60.51	53.97	48.78	41.03	35.51	20.02	10.98	7.64	5.65	4.78	3.49	2.50
RES 3 SOPzV 425	90.76	80.95	73.16	61.55	53.26	30.02	16.47	11.45	8.48	7.16	5.24	3.75
RES 4 SOPzV 565	121.02	107.93	97.55	82.07	71.01	40.03	21.97	15.27	11.31	9.55	6.98	5.00
RES 5 SOPzV 710	151.27	134.92	121.94	102.58	88.77	50.04	27.46	19.09	14.13	11.94	8.73	6.25
RES 6 SOPzV 850	181.53	161.90	146.33	123.10	106.52	60.05	32.95	22.91	16.96	14.33	10.47	7.50
RES 7 SOPzV 990	211.78	188.88	170.72	143.62	124.28	70.06	38.44	26.73	19.79	16.72	12.22	8.75
RES 8 SOPzV 1135	242.04	215.86	195.10	164.13	142.03	80.06	43.93	30.54	22.61	19.10	13.96	10.00
RES 7 SOPzV 1190	245.33	219.29	198.54	167.43	145.14	82.32	45.49	31.76	23.59	19.96	14.62	10.48
RES 8 SOPzV 1360	280.38	250.62	226.91	191.35	165.88	94.08	51.99	36.30	26.96	22.81	16.70	11.98

## Performance Data

### Discharge Constant Power at 20°C (Watts/cell)

End Voltage 1.90 V/cell												
	6 h	7 h	8 h	10 h	12 h	24 h	48 h	72 h	100 h	120 h	168 h	240 h
RES 2 SOPzV 150	29.60	26.36	23.80	20.00	17.30	9.76	5.37	3.75	2.79	2.37	1.74	1.25
RES 3 SOPzV 225	44.40	39.54	35.70	30.00	25.94	14.64	8.06	5.63	4.19	3.55	2.61	1.87
RES 2 SOPzV 280	53.75	48.06	43.52	36.72	31.85	18.12	10.04	7.02	5.22	4.42	3.25	2.34
RES 3 SOPzV 425	80.63	72.09	65.29	55.09	47.78	27.18	15.06	10.53	7.83	6.64	4.88	3.51
RES 4 SOPzV 565	107.51	96.12	87.05	73.45	63.71	36.24	20.08	14.04	10.45	8.85	6.50	4.68
RES 5 SOPzV 710	134.39	120.15	108.81	91.81	79.63	45.30	25.10	17.55	13.06	11.06	8.13	5.85
RES 6 SOPzV 850	161.26	144.18	130.57	110.17	95.56	54.35	30.12	21.06	15.67	13.27	9.75	7.02
RES 7 SOPzV 990	188.14	168.21	152.33	128.54	111.49	63.41	35.14	24.57	18.28	15.49	11.38	8.19
RES 8 SOPzV 1135	215.02	192.24	174.10	146.90	127.41	72.47	40.16	28.08	20.89	17.70	13.00	9.36
RES 7 SOPzV 1190	214.95	192.67	174.83	147.96	128.61	73.76	41.25	28.99	21.65	18.37	13.54	9.76
RES 8 SOPzV 1360	245.66	220.20	199.80	169.09	146.99	84.29	47.14	33.13	24.74	21.00	15.47	11.16

End Voltage 1.94 V/cell												
	6 h	7 h	8 h	10 h	12 h	24 h	48 h	72 h	100 h	120 h	168 h	240 h
RES 2 SOPzV 150	26.01	23.22	21.01	17.71	15.36	8.75	4.85	3.41	2.54	2.16	1.59	1.15
RES 3 SOPzV 225	39.01	34.84	31.52	26.57	23.04	13.12	7.28	5.11	3.82	3.24	2.39	1.72
RES 2 SOPzV 280	46.73	41.89	38.02	32.19	28.00	16.10	9.01	6.34	4.74	4.02	2.97	2.15
RES 3 SOPzV 425	70.10	62.84	57.03	48.29	42.00	24.15	13.52	9.50	7.10	6.03	4.45	3.22
RES 4 SOPzV 565	93.46	83.78	76.04	64.38	56.00	32.20	18.03	12.67	9.47	8.04	5.94	4.29
RES 5 SOPzV 710	116.83	104.73	95.05	80.48	70.00	40.26	22.54	15.84	11.84	10.05	7.42	5.37
RES 6 SOPzV 850	140.20	125.67	114.05	96.57	84.00	48.31	27.04	19.01	14.21	12.07	8.90	6.44
RES 7 SOPzV 990	163.56	146.62	133.06	112.67	98.00	56.36	31.55	22.18	16.57	14.08	10.39	7.51
RES 8 SOPzV 1135	186.93	167.56	152.07	128.77	112.00	64.41	36.06	25.35	18.94	16.09	11.87	8.59
RES 7 SOPzV 1190	183.90	165.30	150.35	127.76	111.44	64.84	36.76	26.01	19.53	16.62	12.30	8.92
RES 8 SOPzV 1360	210.17	188.92	171.83	146.02	127.36	74.10	42.01	29.73	22.32	19.00	14.06	10.19

End Voltage 2.00 V/cell												
	6 h	7 h	8 h	10 h	12 h	24 h	48 h	72 h	100 h	120 h	168 h	240 h
RES 2 SOPzV 150	18.97	17.03	15.48	13.15	11.47	6.68	3.79	2.69	2.02	1.73	1.28	0.93
RES 3 SOPzV 225	28.46	25.55	23.22	19.73	17.21	10.03	5.68	4.03	3.04	2.59	1.92	1.40
RES 2 SOPzV 280	33.46	30.17	27.51	23.50	20.59	12.20	7.00	4.99	3.77	3.22	2.40	1.76
RES 3 SOPzV 425	50.19	45.25	41.27	35.25	30.89	18.30	10.51	7.49	5.65	4.83	3.60	2.63
RES 4 SOPzV 565	66.92	60.33	55.02	47.00	41.18	24.41	14.01	9.98	7.54	6.44	4.80	3.51
RES 5 SOPzV 710	83.66	75.41	68.78	58.75	51.48	30.51	17.51	12.48	9.42	8.05	6.00	4.39
RES 6 SOPzV 850	100.39	90.50	82.54	70.49	61.77	36.61	21.01	14.98	11.31	9.66	7.20	5.27
RES 7 SOPzV 990	117.12	105.58	96.29	82.24	72.07	42.71	24.51	17.47	13.19	11.27	8.40	6.14
RES 8 SOPzV 1135	133.85	120.66	110.05	93.99	82.36	48.81	28.02	19.97	15.08	12.88	9.60	7.02
RES 7 SOPzV 1190	126.77	114.71	104.99	90.20	79.44	48.07	28.14	20.24	15.38	13.17	9.59	6.71
RES 8 SOPzV 1360	144.88	131.10	119.99	103.09	90.79	54.93	32.16	23.14	17.57	15.05	10.96	7.67



## **SYSTEMS SUNLIGHT S.A.**

### **Headquarters**

2 Ermou & Nikis Str., Syntagma Sq.

105 63 Athens, Attica, Greece

**T** +30 210 6245400

**F** +30 210 6245409

### **European Manufacturing Plant**

Neo Olvio

672 00 Xanthi, Greece

**T** +30 25410 48100

**F** +30 25410 95446

### **Global Service Department**

366 Tatoiou Str.

136 73 Acharnes, Attica, Greece

**T** +30 210 6245600

**F** +30 210 6245619

**[www.systems-sunlight.com](http://www.systems-sunlight.com)**



Member of SUNLIGHT Global Partners Network